

→ corner aluminium frame
- general view

- made of extruded aluminium, non-welded, assembled by corner connectors
- equipped with a rubber gasket, factory-fitted
- equipped with intumescent gasket for fire doors or EPDM gasket for non-fire doors; installed on site
- resistant to corrosion in humid conditions
- powder coated to any RAL palette colour

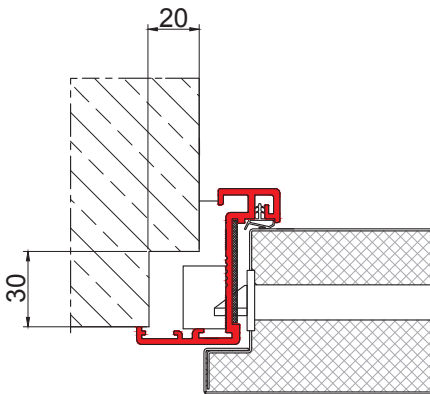

→ corner frame
- lock side view
- wall notched size
20 x 30 x 170 mm

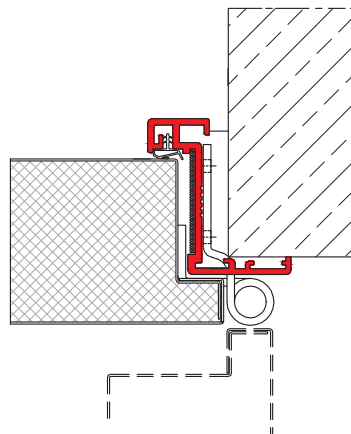

→ corner frame
- hinge side view,
standard hinge

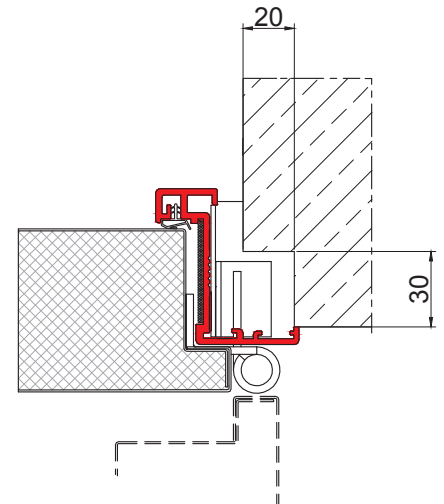

→ corner frame
- hinge side view,
3D adjustable hinge
- wall notched size
20 x 30 x 150 mm

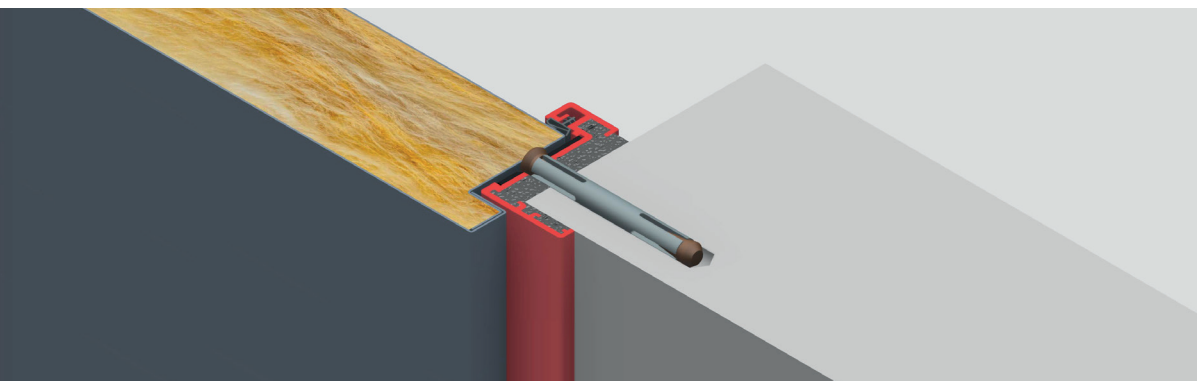

the same model
for doors

- DFM DS 00
- DFM DS 30
- DFM DS 30B
- DFM DS 60
- DFM OS 00

NOTE! Door frame and installation gap to be duly filled, in accordance with certificate

EMBRACING FRAME

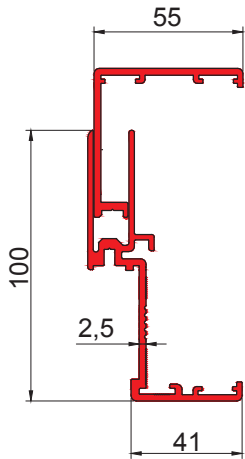

- made of extruded aluminium, non-welded, assembled by corner connectors
- composed of two parts: base element and embracing part made of aluminium or steel depending on wall thickness
- equipped with a rubber gasket, factory-fitted
- equipped with intumescent gasket for fire doors or EPDM gasket for non-fire doors; installed on site
- resistant to corrosion in humid conditions
- powder coated to any RAL palette colour

→ embracing aluminium frame
- general view

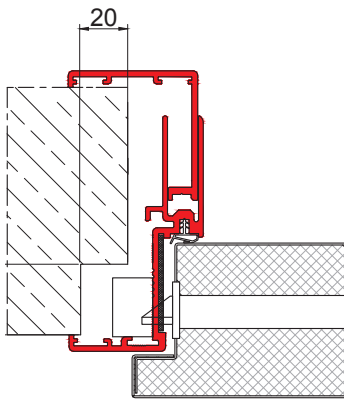

→ embracing frame
- lock side view
- wall notched size
20 x 30 x 170 mm

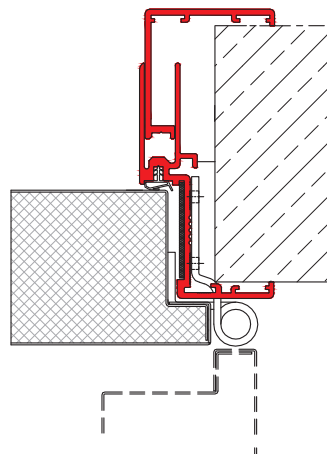

→ embracing frame
- hinge side view,
standard hinge

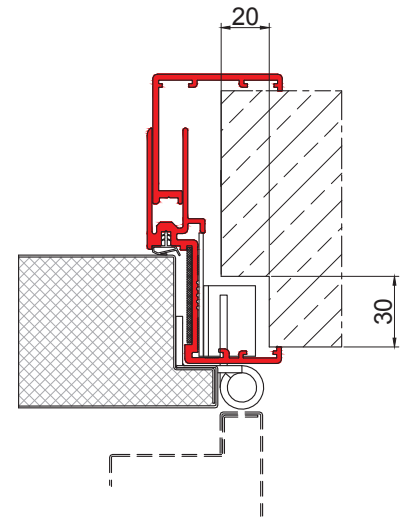

→ embracing frame
- hinge side view,
3D adjustable hinge
- wall notched size
20 x 30 x 150 mm

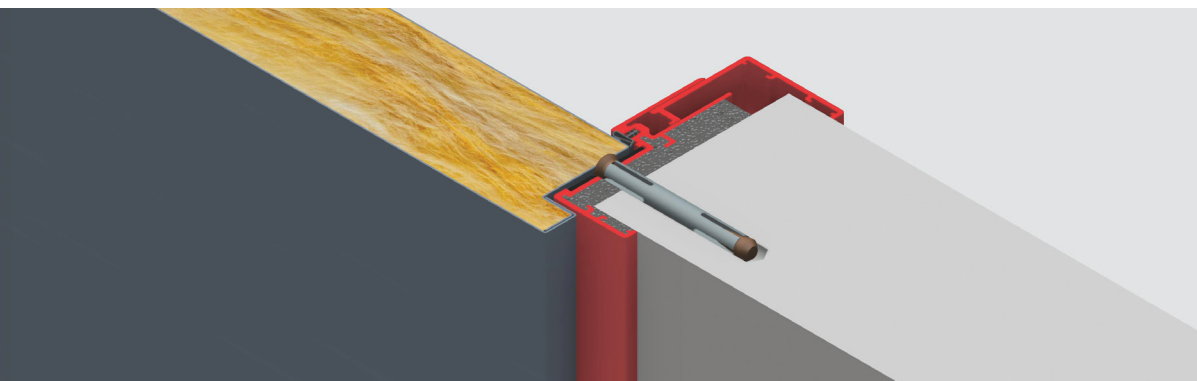

the same model
for doors

- DFM DS 00
- DFM DS 30
- DFM DS 30B
- DFM DS 60
- DFM OS 00

NOTE! Door frame and installation gap to be duly filled, in accordance with certificate

BLOCK FRAME

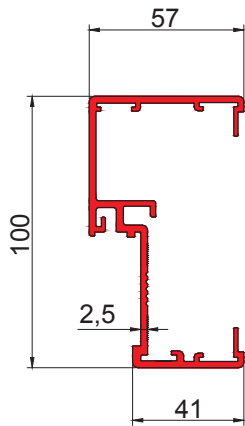

- made of extruded aluminium, non-welded, assembled by corner connectors
- equipped with a rubber gasket, factory-fitted
- equipped with intumescent gasket for fire doors or EPDM gasket for non-fire doors; installed on site
- resistant to corrosion in humid conditions
- powder coated to any RAL palette colour

→ block aluminium frame
- general view

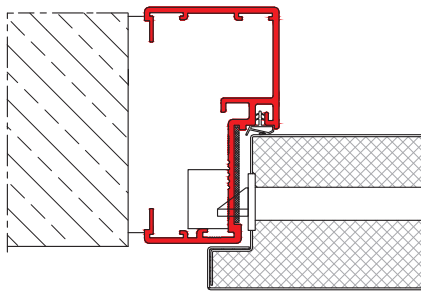

→ block frame
- lock side view

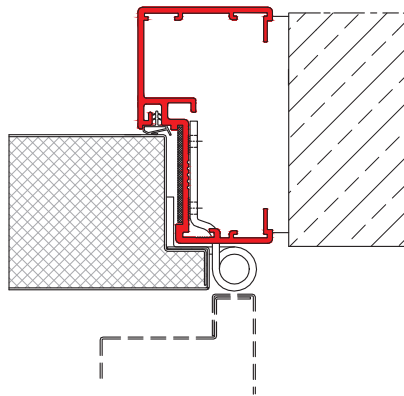

→ block frame
- hinge side view,
standard hinge

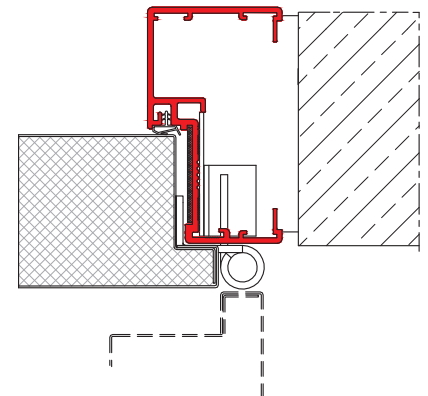

→ block frame
- hinge side view,
3D adjustable hinge

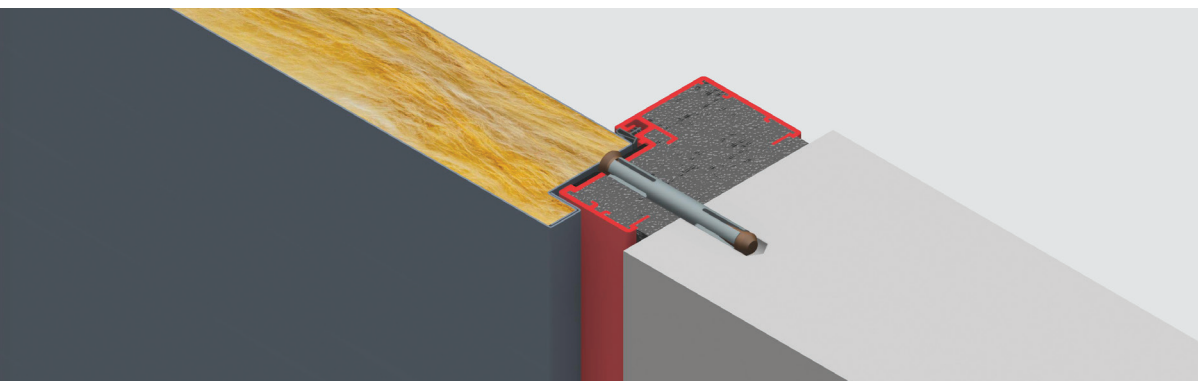

the same model
for doors
DFM DS 00
DFM DS 30
DFM DS 30B
DFM DS 60
DFM OS 00

NOTE! Door frame and installation gap to be duly filled, in accordance with certificate

CORNER FRAME with thermal break

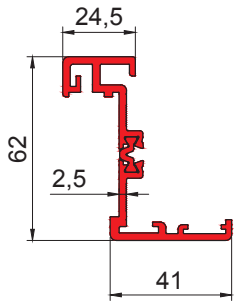

→ corner aluminium frame with thermal break – general view

- made of extruded aluminium, non-welded, assembled by corner connectors
- **formed to hold polyamide band - as thermal break**
- equipped with a rubber gasket, factory-fitted
- equipped with intumescent gasket for fire doors or EPDM gasket for non-fire doors; installed on site
- resistant to corrosion in humid conditions
- powder coated to any RAL palette colour

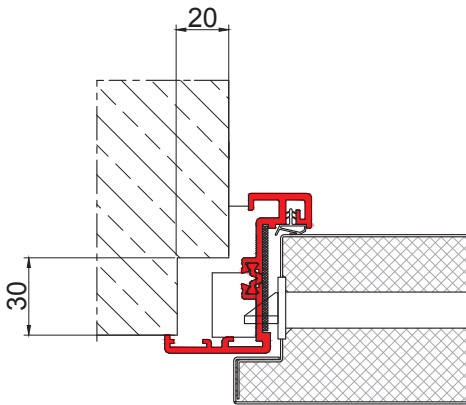

→ corner frame with thermal break
- lock side view
- wall notched size 20 x 30 x 170 mm

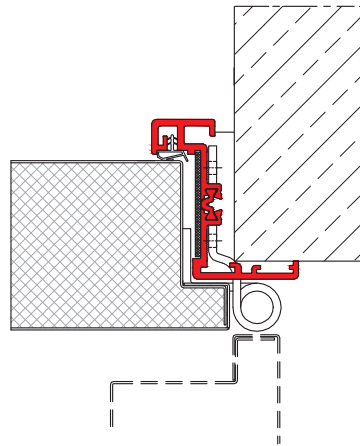

→ corner frame with thermal break
- hinge side view, standard hinge

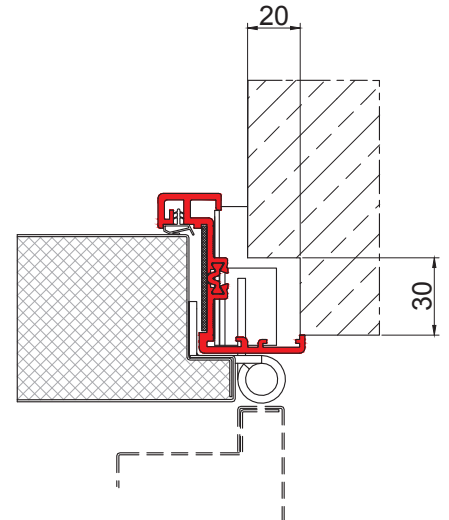

→ corner frame with thermal break
- hinge side view, 3D adjustable hinge
- wall notched size 20 x 30 x 150 mm

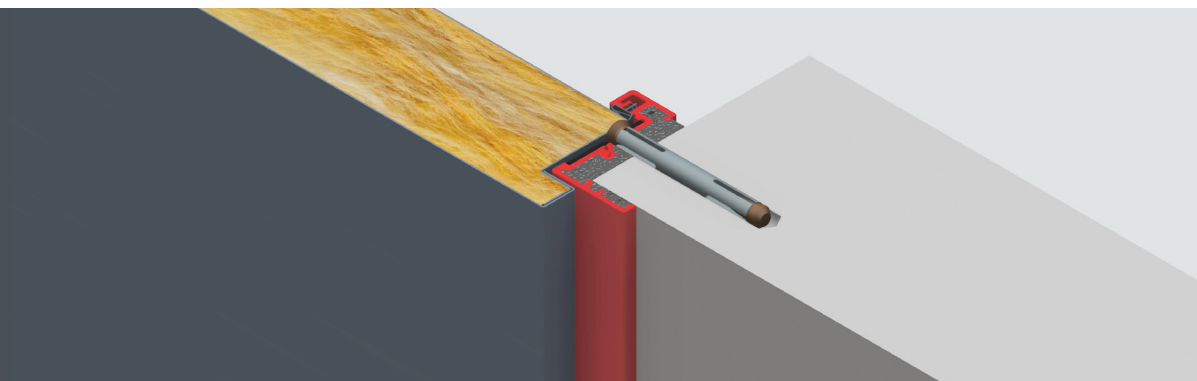

the same model for doors
DFM DS 00
DFM DS 30
DFM DS 30B
DFM DS 60
DFM DS 60B-1
DFM OS 00

NOTE! Door frame and installation gap to be duly filled, in accordance with certificate

EMBRACING FRAME with thermal break

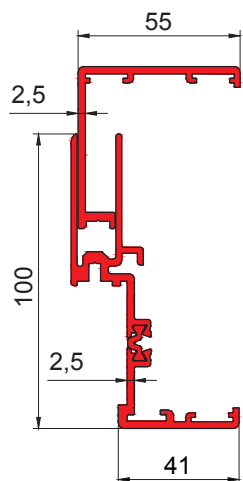

- made of extruded aluminium, non-welded, assembled by corner connectors
- composed of two parts: base element and embracing part made of aluminium or steel depending on wall thickness
- **base part formed to hold polyamide band - as thermal break**
- equipped with a rubber gasket, factory-fitted
- equipped with intumescent gasket for fire doors or EPDM gasket for non-fire doors; installed on site
- resistant to corrosion in humid conditions
- powder coated to any RAL palette colour

→ embracing aluminium frame with thermal break - general view

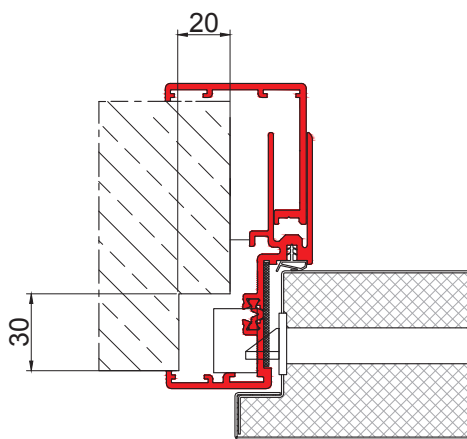

→ embracing frame with thermal break - lock side view - wall notched size 20 x 30 x 170 mm

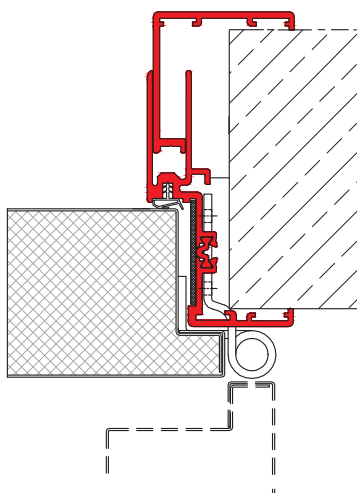

→ embracing frame with thermal break - hinge side view, standard hinge

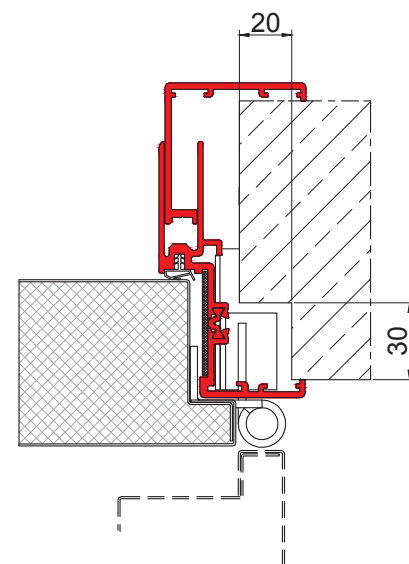

→ embracing frame with thermal break - hinge side view, 3D adjustable hinge - wall notched size 20 x 30 x 150 mm

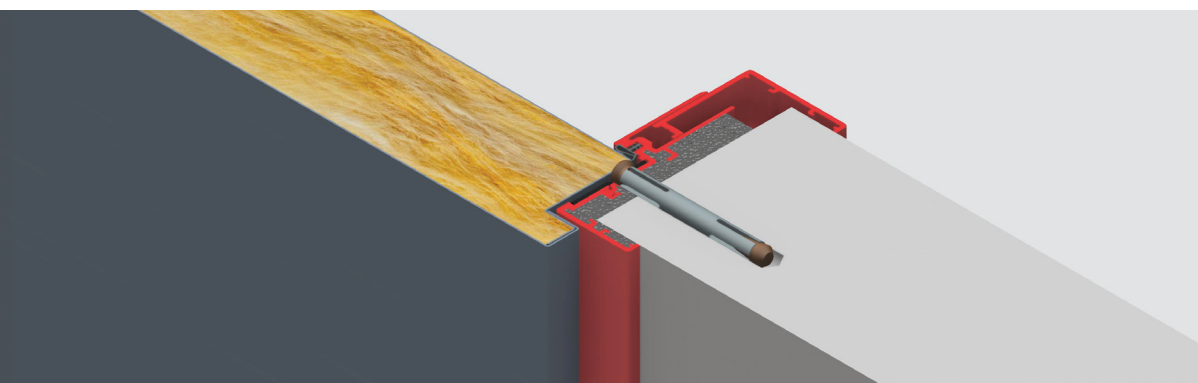

the same model for doors

- DFM DS 00
- DFM DS 30
- DFM DS 30B
- DFM DS 60
- DFM DS 60B-1
- DFM OS 00

NOTE! Door frame and installation gap to be duly filled, in accordance with certificate

BLOCK FRAME with thermal break

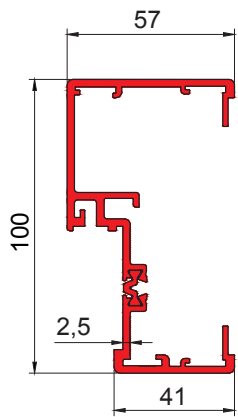

- made of extruded aluminium, non-welded, assembled by corner connectors
- **formed to hold polyamide band- as thermal break**
- equipped with a rubber gasket, factory- fitted
- equipped with intumescent gasket for fire doors or EPDM gasket for non-fire doors; installed on site
- resistant to corrosion in humid conditions
- powder coated to any RAL palette colour

→ block aluminium frame with thermal break
- general view

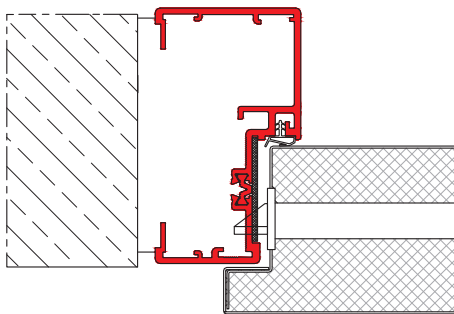

→ block frame with thermal break
- lock side view

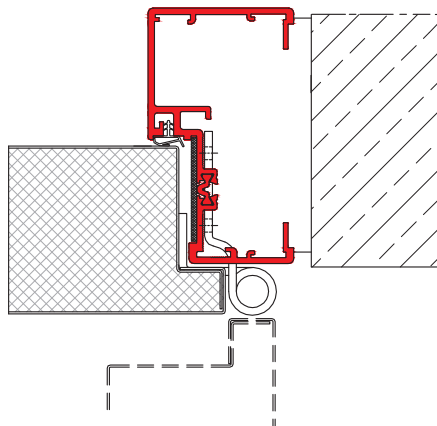

→ block frame with thermal break
- hinge side view,
standard hinge

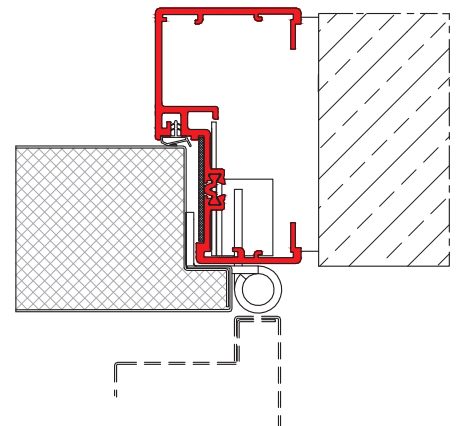

→ block frame with thermal break
- hinge side view,
3D adjustable hinge

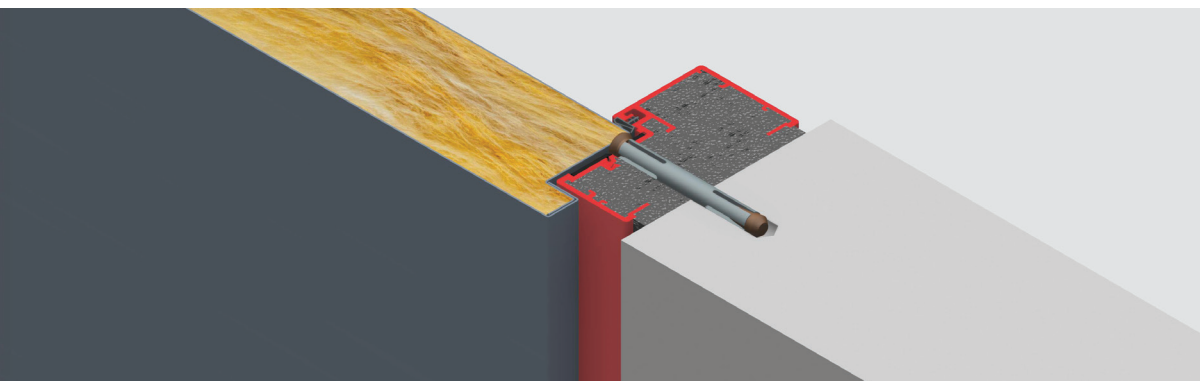

the same model
for doors

- DFM DS 00
- DFM DS 30
- DFM DS 30B
- DFM DS 60
- DFM DS 60B-1
- DFM OS 00

NOTE! Door frame and installation gap to be duly filled, in accordance with certificate

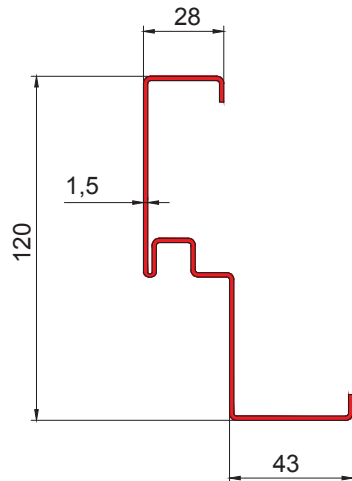

- made of steel, thickness 1.5 mm, welded
- equipped with a rubber gasket, factory- fitted
- equipped with intumescent gasket; installed on site
- resistant to corrosion in humid conditions
- powder coated to any RAL palette colour

→ corner steel frame
- general view

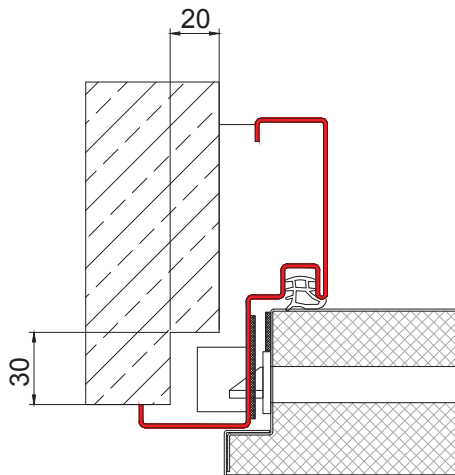

→ corner steel frame
- lock side view
- wall notched size 20 x 30 x 170 mm

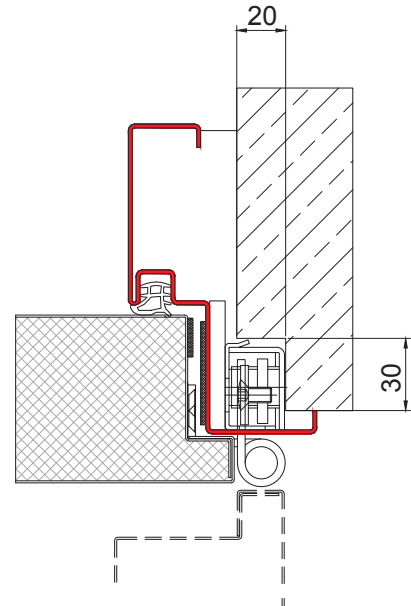

→ corner steel frame
- hinge side view, 3D adjustable hinge
- wall notched size 20 x 30 x 150 mm

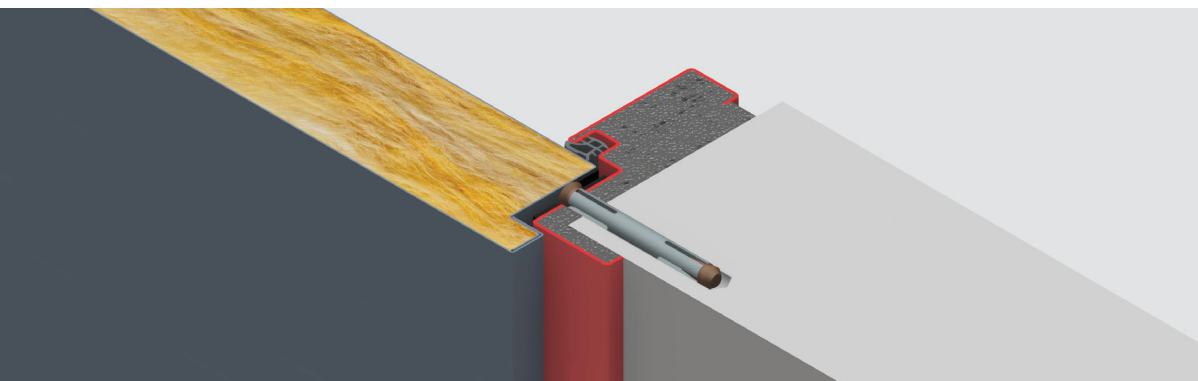

the same model
for fire doors
DFM DS 120
DFM OS 60

NOTE! Door frame and installation gap to be duly filled, in accordance with certificate

EMBRACING FRAME

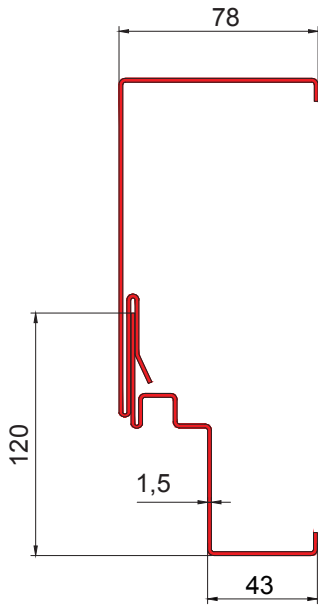

→ embracing steel frame
- general view

- made of steel, thickness 1.5 mm, welded
- composed of two parts, base element and embracing part made of steel
- equipped with a rubber gasket, factory-fitted
- equipped with intumescent gasket; installed on site
- resistant to corrosion in humid conditions
- powder coated to any RAL palette colour

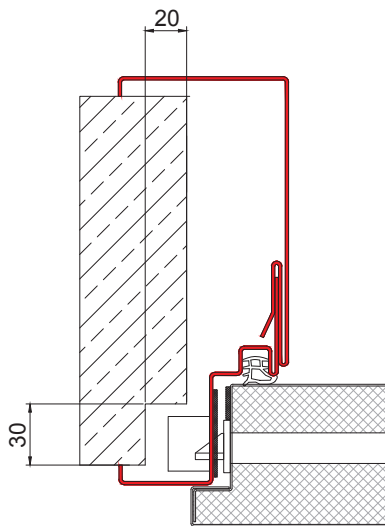

→ embracing steel frame
- lock side view
- wall notched size 20 x 30 x 170 mm

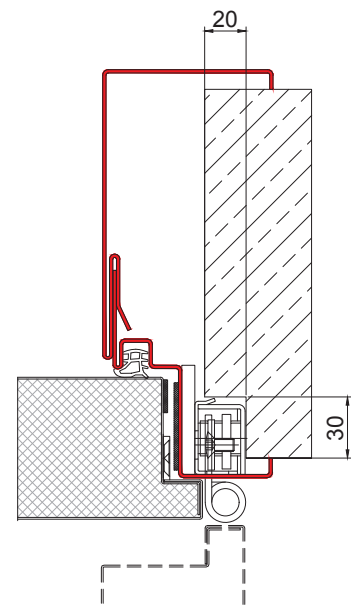

→ embracing steel frame
- hinge side view, 3D adjustable hinge
- wall notched size 20 x 30 x 150 mm

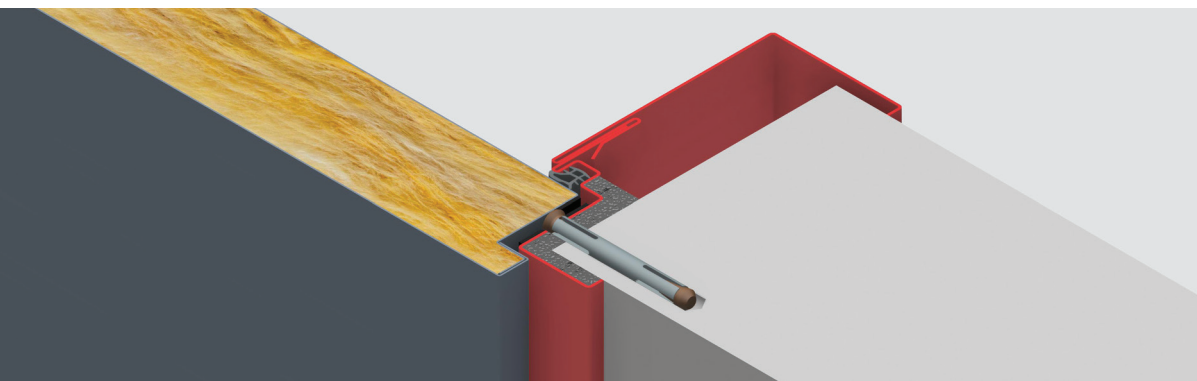

the same model
for fire doors
DFM DS 120
DFM OS 60

NOTE! Door frame and installation gap to be duly filled, in accordance with certificate

BLOCK FRAME

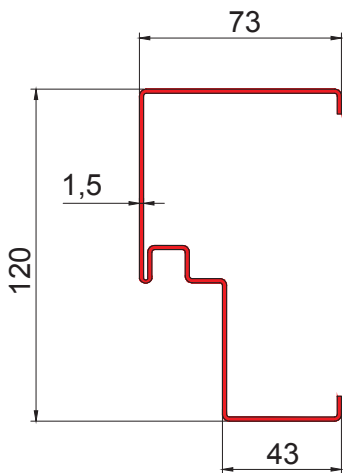

- made of steel, thickness 1.5 mm, welded
- equipped with a rubber gasket, factory- fitted
- equipped with intumescent gasket; installed on site
- resistant to corrosion in humid conditions
- powder coated to any RAL palette colour

→ block steel frame
- general view

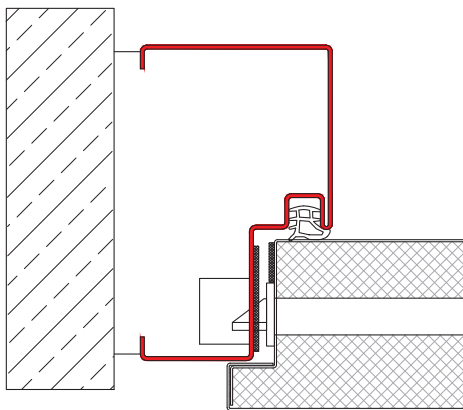

→ block steel frame
- lock side view

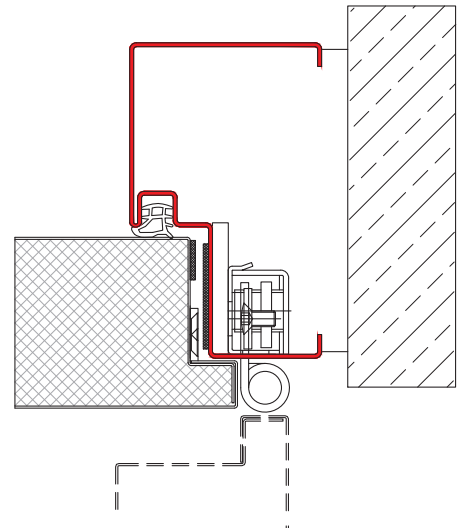

→ block steel frame
- hinge side view, 3D adjustable hinge

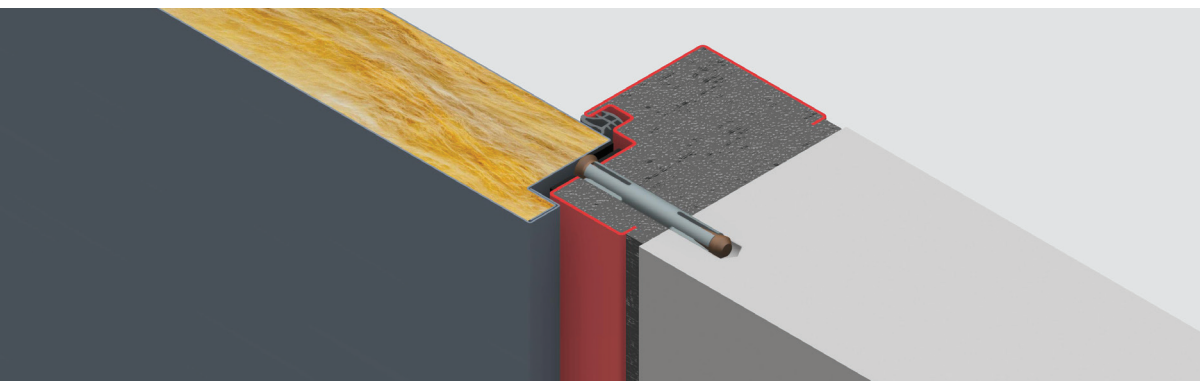

the same model
for fire doors
DFM DS 120
DFM OS 60

NOTE! Door frame and installation gap to be duly filled, in accordance with certificate

CORNER FRAME with hidden rebate (HP)

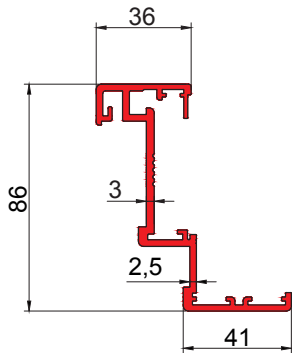

- made of extruded aluminium, non-welded, assembled by corner connectors
- **shaped to hide door leaf rebate**
- equipped with a rubber gasket, factory-fitted
- equipped with intumescent gasket for fire doors or EPDM gasket for non-fire doors; installed on site
- resistant to corrosion in humid conditions
- powder coated to any RAL palette colour

→ corner aluminium frame for doors with hidden rebate – general view

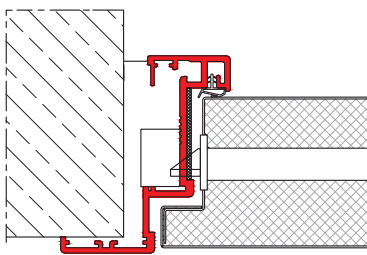

→ corner frame for doors with hidden rebate - lock side view

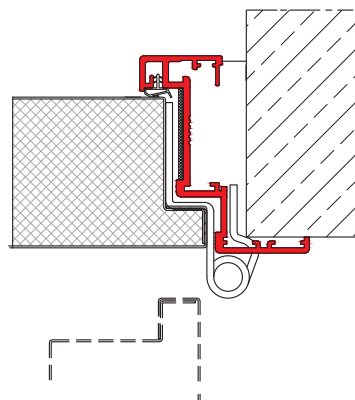

→ corner frame for doors with hidden rebate - hinge side view, standard hinge

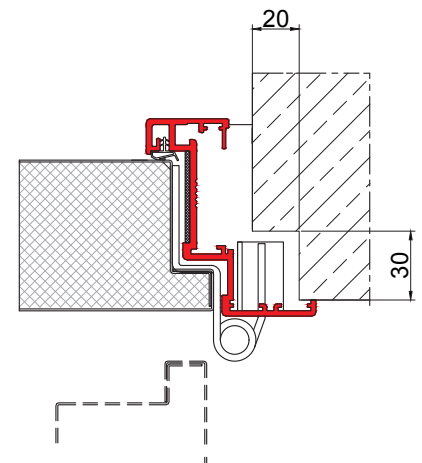

→ corner frame for doors with hidden rebate - hinge side view, 3D adjustable hinge - wall notched size 20 x 30 x 150 mm

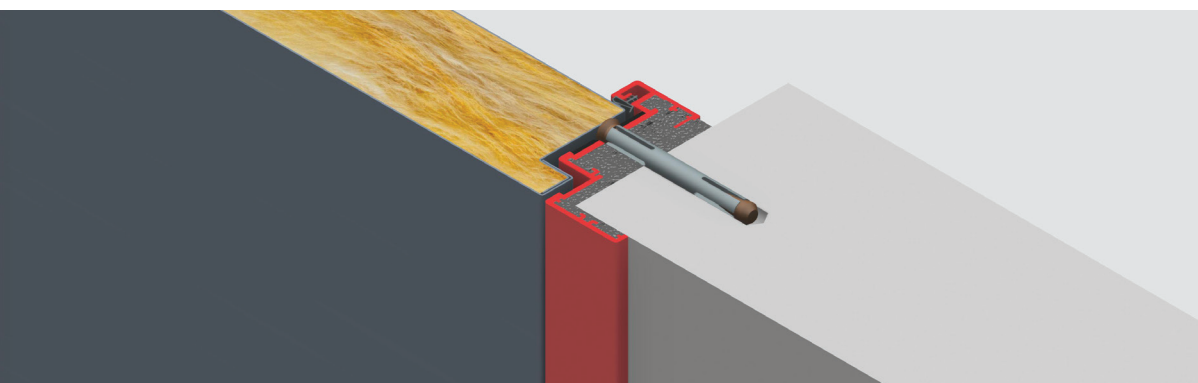

the same model for doors
DFM DS HP 00
DFM DS HP 30
DFM DS HP 30B
DFM DS HP 60
DFM OS HP 00

NOTE! Door frame and installation gap to be duly filled, in accordance with certificate

EMBRACING FRAME with hidden rebate (HP)

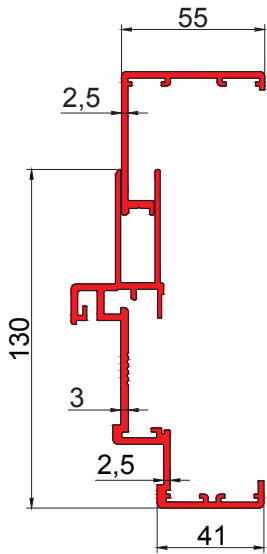

→ embracing aluminium frame for doors with hidden rebate – general view

- made of extruded aluminium, non-welded, assembled by corner connectors
- **shaped to hide door leaf rebate**
- composed of two parts: base element and embracing part made of aluminium or steel depending on wall thickness
- equipped with a rubber gasket, factory-fitted
- equipped with intumescent gasket for fire doors or EPDM gasket for non-fire doors; installed on site
- resistant to corrosion in humid conditions
- powder coated to any RAL palette colour

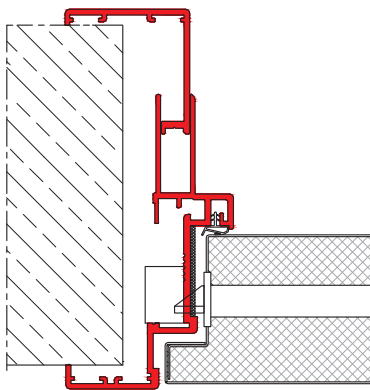

→ embracing frame for doors with hidden rebate - lock side view

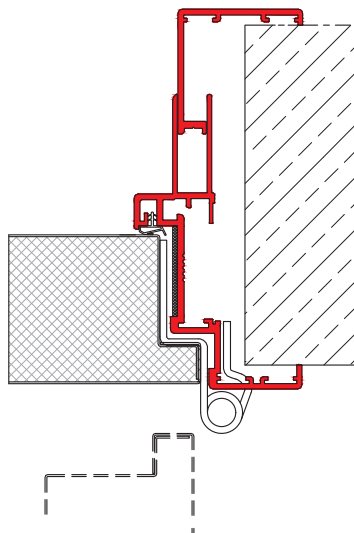

→ embracing frame for doors with hidden rebate - hinge side view, standard hinge

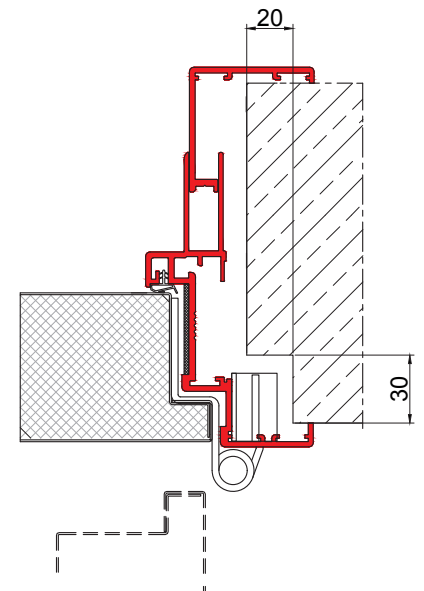

→ embracing frame for doors with hidden rebate - hinge side view, 3D adjustable hinge - wall notched size 20 x 30 x 150 mm

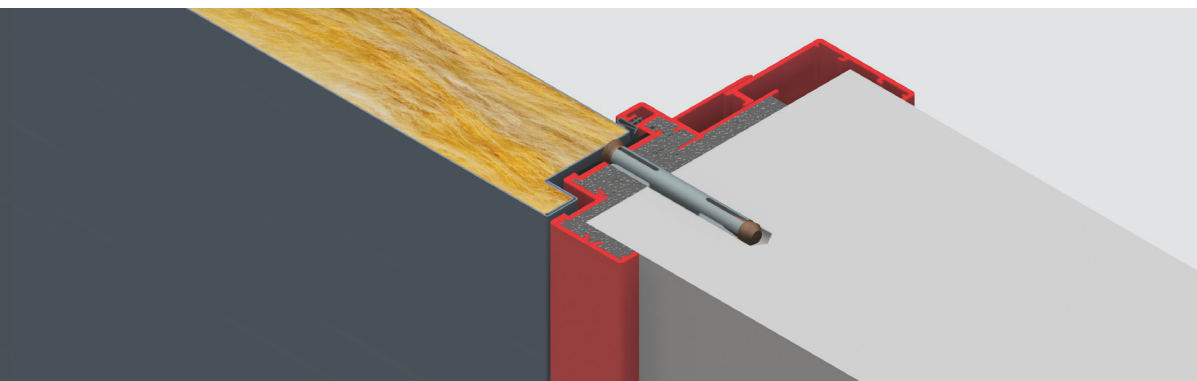

the same model for doors
DFM DS HP 00
DFM DS HP 30
DFM DS HP 30B
DFM DS HP 60
DFM OS HP 00

NOTE! Door frame and installation gap to be duly filled, in accordance with certificate

BLOCK FRAME with hidden rebate (HP)

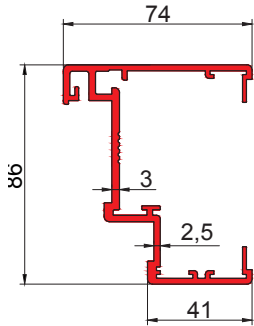

- made of extruded aluminium, non-welded, assembled by corner connectors
- **shaped to hide door leaf rebate**
- equipped with a rubber gasket, factory-fitted
- equipped with intumescent gasket for fire doors or EPDM gasket for non-fire doors; installed on site
- resistant to corrosion in humid conditions
- powder coated to any RAL palette colour

→ block aluminium frame for doors with hidden rebate – general view

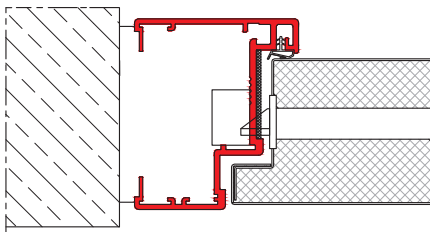

→ block frame for doors with hidden rebate – lock side view

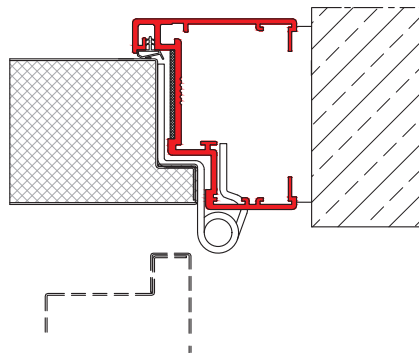

→ block frame for doors with hidden rebate – hinge side view, standard hinge

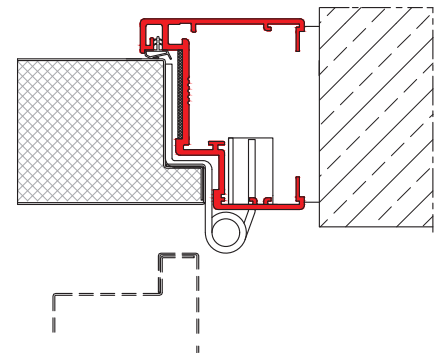

→ block frame for doors with hidden rebate – hinge side view, 3D adjustable hinge

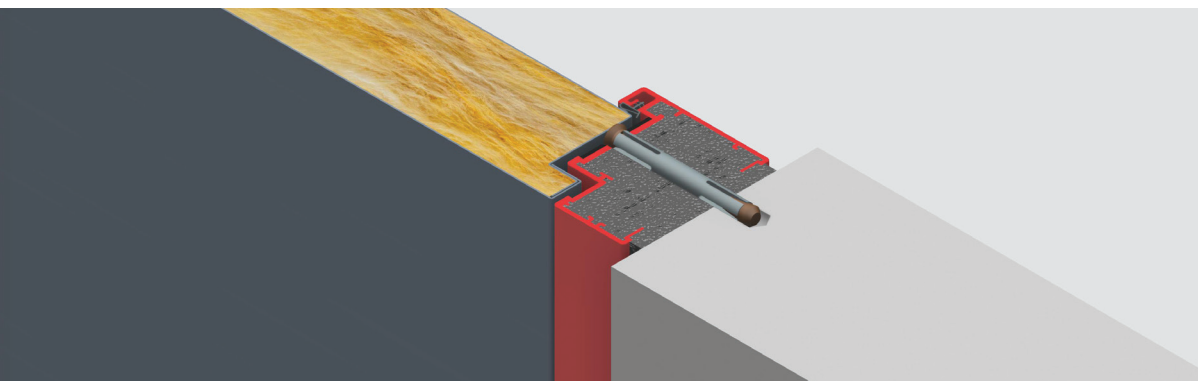

the same model for doors

- DFM DS HP 00
- DFM DS HP 30
- DFM DS HP 30B
- DFM DS HP 60
- DFM OS HP 00

NOTE! Door frame and installation gap to be duly filled, in accordance with certificate